



Global engineering. Personally refined.



German Engineering

Tailored with German engineering, our world-class home elevators are here to make jaws drop.

Transform the dreams of your family into reality and access a home elevator that matches your comfort, preferences and individuality.

The rich and expansive heritage of German engineering and Italian design present in our home elevators offer a sophisticated, elegant and fascinating experience. Discover a range of curated customisation options with tones, textures and upholstery that effortlessly complement your home.

From our internationally recognised elevator technology, we have developed a luxe home elevator range, the E Series, that offers numerous configurations for almost every requirement.

The E Series range utilises the best-available home elevator technology, offering a solution that is extremely energy efficient and quieter than a quiet room. Combine this with our thorough approach to engineering and our love for Italian design to find a solution that is environmentally conscious, unobtrusive and integrates beautifully into your home. Safety and comfort are instilled in our design - you'd be hard-pressed to find the two in one place anywhere else.



Yours sincerely,

Dirk Marschall, TK Home Solutions - COO

“

The E Series is TK Access Solutions' most versatile home lift.



The Pinnacle of Home Opulence

The E Series, or the E300, incorporates the innovative and patented CogBelt technology into its drive. The gearless drive system offers unbelievable levels of comfort and performance. A truly global home elevator with superior performance, it can go up to 0.4 m/s depending on local codes and standards relevant to the market. Our designers have crafted stylish décor combinations that fuse luxury materials and finishes while giving you the freedom to design your home elevator. E Series can be customised in every detail and dimension to perfectly match your home décor.



Performance With Style

Through our expertise in engineering, we have developed a high-quality gearless home elevator. The result is a high-performance addition to your home that you can hardly hear, even when you put your ear right next to the walls. Select furnishings from our beautiful cabin styles and options and you've got the perfect home elevator.



Dependable Solutions

In case of a power failure, our home elevators will continue to work from a battery, allowing the user to reach the ground floor safely. It is also possible to connect a fire alarm system to the main electronic board.

Safety Is In Our DNA

The E Series range boasts an extensive list of safety features. It carries a Safety Integrity Level (SIL) 3 certified safety system making it the first in the home elevator market. Unlike some home elevators, we have a separate safety system, away from the OSG, which means it will not be affected by any mechanical faults.



Luxe Comfort

We believe that access to your home deserves to be a comfortable experience. Taking advantage of the gearless technology, the E Series enables us to deliver a smooth and quiet journey from start to finish. In addition, they come with a patented gentle soft start and stop device. Each home elevator is fitted with a handrail and push-to-run buttons making the journey as seamless and as safe as possible.





E Series With Shaft

The E Series with shaft has an in-built patented metal structure that does not require a separate shaft or support.

E Series Without Shaft

The E Series without shaft requires a separate structure built of concrete, brick or metal fabrication.





E300 Specification

Superior Performance With Style. Incorporates Innovative Gearless CogBelt Technology. Luxurious with an unbelievably smooth, silent and fast ride.

Technical compliance:

Machinery Directive 2006/42/EC EN81-41/SIL 3

Drive system:

Gearless with cogbelt drive

Rated speed:

0.15 m/s up to 0.4 m/s

Rated load:

Up to 400 kg

Travel height:

Up to 18,000 mm

Number of stops:

Max. 6 stops per lift

Number of doors:

Max. 12 doors per lift

Pit:

140 mm (no pit is required in case of threshold/ramp)

Shaft top height:

2500 mm in existing shaft / 2600 mm with its own shaft

Platform control:

Automatic (one-touch) with call reservation

Environment:

Indoor / Outdoor

Emergency lowering:

Battery-operated emergency lowering

Control voltage:

24V

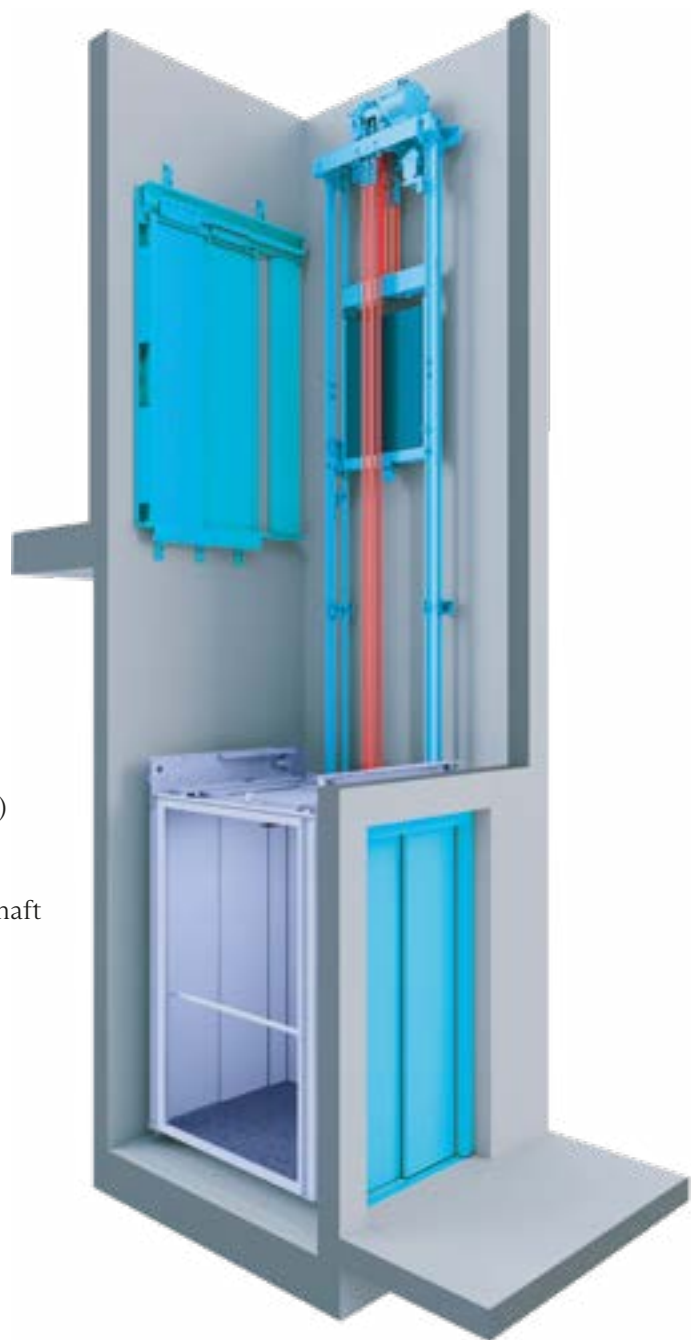



E200 Specification

The E200 Incorporates Proven and Reliable Hydraulic Technology and Offers Comfort and Performance

Technical compliance:

European Machinery Directive 2006/42/EC Reference standard: EN 81-41/SIL 3

Drive system:

Hydraulic control unit with indirect action by chains

Rated speed:

0.15 m/s up to 0.3 m/s

Rated load:

Up to 400 kg

Travel height:

12600 to 13100 mm

Number of stops:

Max. 6 stops per lift

Number of doors:

Max. 12 doors per lift

Pit:

120 mm (no pit is required when there is a threshold/ramp)

Shaft top height:

Standard 2300 mm depending on shaft type and landing doors.

Platform control:

Automatic (one-touch) with call reservation

Environment:

Indoor / Outdoor

Emergency lowering:

Battery-operated emergency lowering

Control voltage:

24V

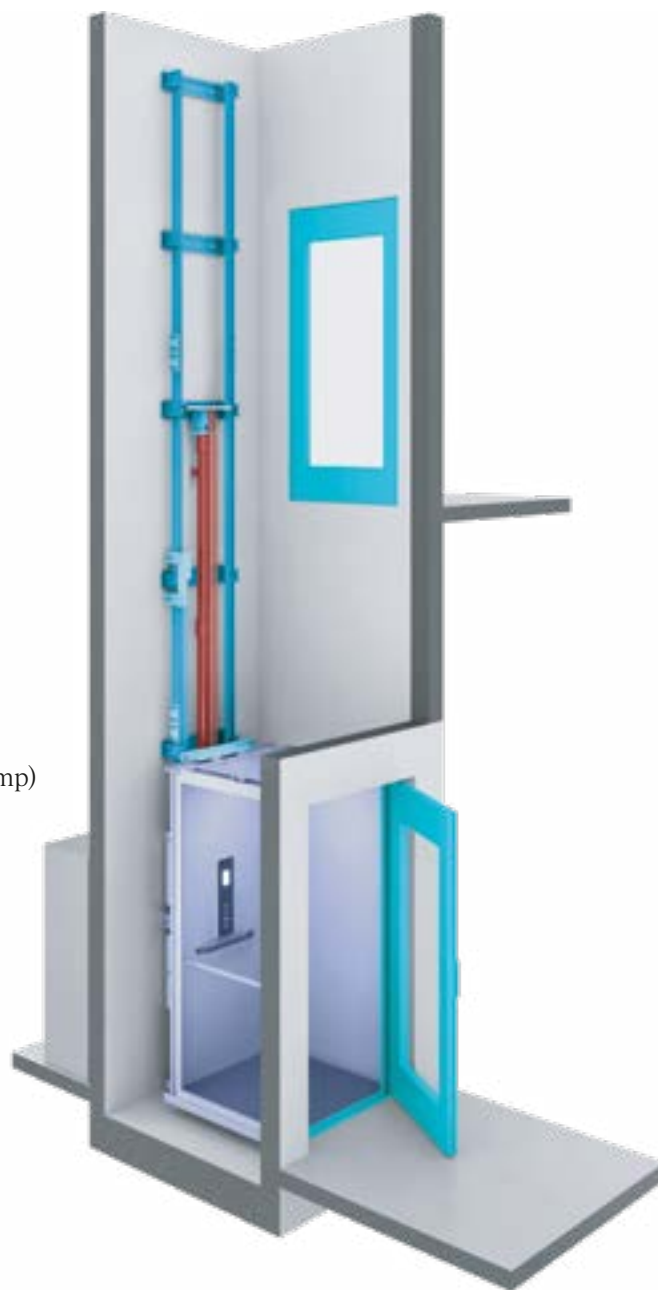



Elegance Cabin - Layout

Suspended ceiling:

- ▶ Opal (1)
- ▶ Round (2)
- ▶ Plain steel (3)
- ▶ Starry sky - Stainless Steel (4)

Access Side:

- ▶ Folding door (1)
- ▶ Sliding door (2)
- ▶ Matching finish to cabin wall

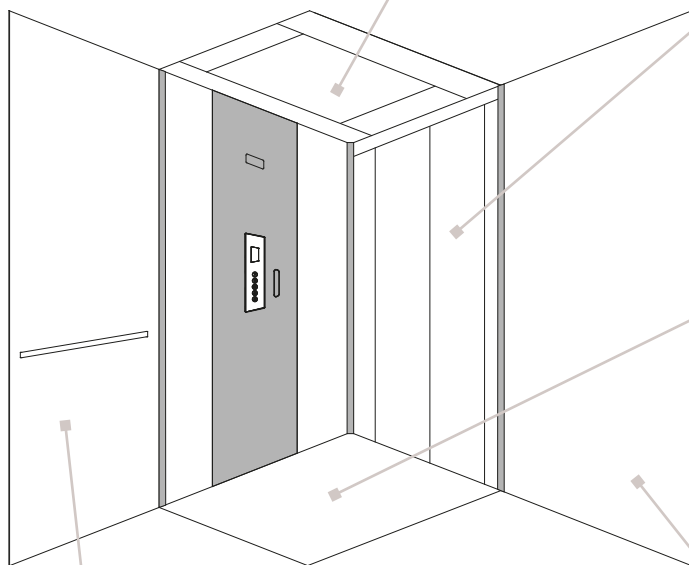

Flooring:

- ▶ At choice from our catalogue (1)
- ▶ Prepared for Customer application (2)

Cabin Wall:

- ▶ Blind Wall (1)
- ▶ Half Panoramic (2)
- ▶ Full Panoramic (3)

Half and Full Panoramic in the same finish as blind wall
Handrail not included - Mandatory on Full Panoramic for Public Access solutions

Mirror for cabin wall:

- ▶ Slat vertical - Fixed (1)
- ▶ Dimensions (1)
- ▶ Half wall (2)
- ▶ Full wall (3)

Elegance Cabin - Finishes

Cabin Wall

LAMINATE - WOOD



Dark wood 4303



Bright wood 4367

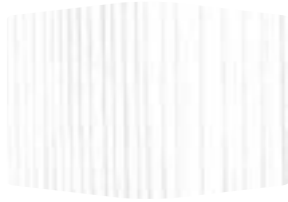

Bright wood 4515



Bright wood 4533



Warm wood 4511

LAMINATE - TEXTURE

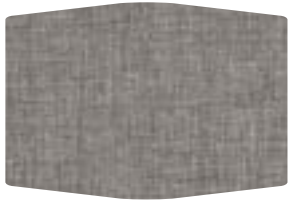

Tx 3318



Tx 4485

STAINLESS STEEL

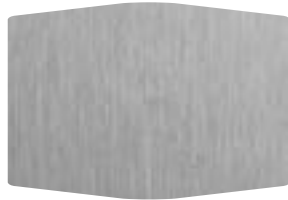

Stainless Steel Satin

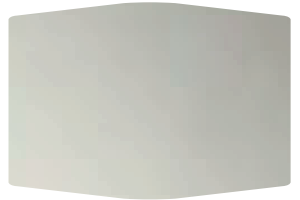

Stainless Steel Mirror

LAMINATE - CONCRETE



Cr 868



Cr 585

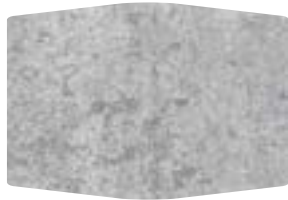

Cr 3331



Cr 546 (former Cr 1117)

ACCENT - CORNERS AND CENTRAL PANEL

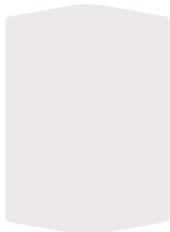

9003

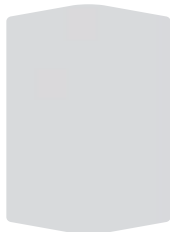

7035



7012



7021



Satin



Mirror



Gold



1019



3003



6011



5024

Real colours and layouts may differ from those shown. Slightly noticeable differences are possible because of different materials. Contents are subject to change without notice.

Elegance - Finishes

Flooring

Choose between the following options for safety vinyl flooring with guaranteed lifetime non-slip.

VINYL



White



Sand

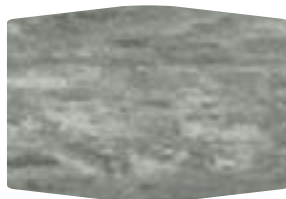

Grey

STONES



White



Sand



Grey



Black

CARPETS

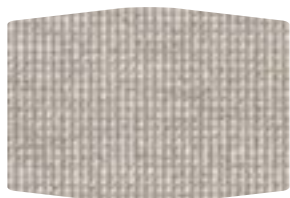

White

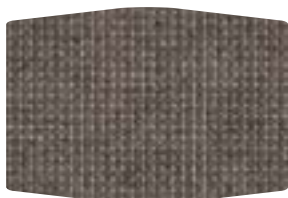

Sand



Grey

Ceiling

The following options are different designs for the LED ceiling of your home elevator.

- Opal (standard)
- Plain
- Round
- Starry Sky



Starry sky is stainless steel satin. The other ceilings are in RAL9010 (white) painted steel. As option can be ordered in Stainless Steel Satin



Elegance Cabin - Optional Upgrades

Cabin Interior - Standard

- ▶ Centre Panel & Corners - RAL / SS Satin
- ▶ Cabin Walls - SS (Satin / Mirror) Wood laminates
- ▶ Ceiling - Opal with RAL 9010
- ▶ Floor - Vinyl (Black, White, Sand)
- ▶ COP - Black
- ▶ Autodialer
- ▶ 1 No. SS Hand Rail

Elegance Cabin Interior - Options

- ▶ Centre Panel & Corners - RAL, SS (Mirror/ Gold)
- ▶ Ceiling - Round / Plain Steel (RAL 9010), Starry Sky
- ▶ Floor - Carpet, Stone, Own Flooring
- ▶ Full / Half Mirror Height & Slim Vertical
- ▶ Full / Half Panoramic Wall
- ▶ Handrail SS - Satin /Gold Satin
- ▶ COP - Mirror / Gold
- ▶ External Coating - SS Cabin Per Wall, Door & Roof
- ▶ Autodialer + GSM
- ▶ Integration with building Fire Alarm

Other - Options

- ▶ Power Pack Extention upto 10 meters
- ▶ Customized plan Size out of Standards
- ▶ Oil Heater for temperature <+5 Degree Celsius
- ▶ LCD Landing Display
- ▶ Landing Door Key - Includes School Locking Function
- ▶ i-Button - includes School Locking Function

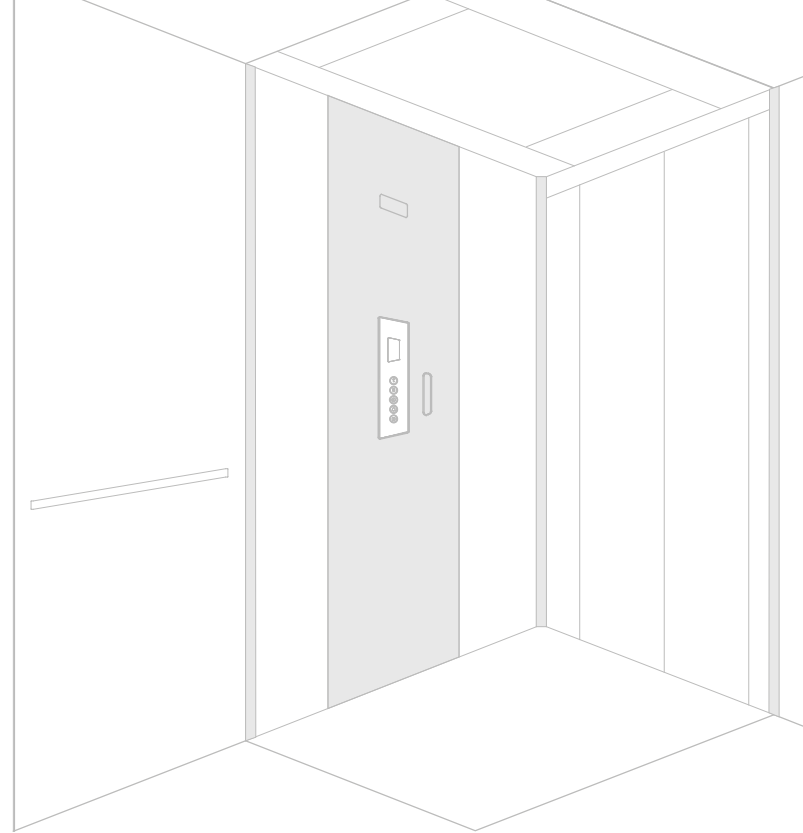

Cabin Sliding Door - Standard

- ▶ upto 900 mm - Finished in RAL
- ▶ upto 900 mm - Finished in SS Satin

Landing Door - Standard

- ▶ Upto 900 mm - Finished in Skinplate
- ▶ SS Door Handle - Techno

Cabin Sliding Door - Options

- ▶ Panoramic - Finished in SS Satin

Sliding Landing Door - Options

- ▶ Finished in - SS Satin, RAL, RAL Metallic

Swing Landing Door - Options

- ▶ Panoramic Glass on Door (Smokey Grey, Opaline, Smokey Satin, Half Reflecting)
- ▶ RAL STD Colour & Metallic
- ▶ SS Door Handle - Modern
- ▶ Automatic EVO Door Opener and Closer
- ▶ Steel Blind Covered in SS 441 Satin (Indoor)

Elegance Cabin - Designer's choice

1



Modern Europe

Wall : Bright Wood 4515
Accent : Black 7021
Ceiling : Round
Flooring : Grey Vinyl
Mirror : none
Handrail : S.Steel 2 pieces
 (for 1400 wide cabin only)

2



Modern Americas

Wall : Concrete 3331
Accent : Blue 5024
Ceiling : Plain
Flooring : Grey Vinyl
Mirror : Slat vertical
Handrail : S.Steel 2 pieces
 (for 1400 wide cabin only)

3



Modern Asia

Wall : Texture 2606
Accent : Red 3003
Ceiling : Opal
Flooring : Grey Vinyl
Mirror : none
Handrail : S.Steel 2 pieces
 (for 1400 wide cabin only)

1



Classic Europe

Wall : Cool Wood 4511
Accent : Beige 1019
Ceiling : Plain
Flooring : Sand Carpet
Mirror : Full Wall
Handrail : S.Steel 2 pieces
 (for 1400 wide cabin only)

2



Classic Americas

Wall : Texture 3318
Accent : Light Grey 7035
Ceiling : Plain
Flooring : Grey Vinyl
Mirror : Full Height Panoramic wall
Handrail : S.Steel 1 piece onto
 panoramic wall

3



Classic Asia

Wall : Dark Wood 4303
Accent : Red 3003
Ceiling : Plain
Flooring : Grey Vinyl
Mirror : Half Wall
Handrail : S.Steel 2 pieces
 (for 1400 wide cabin only)

Elegance Cabin - Designer's choice

1



Natural Europe

- Wall** : Warm Wood 4533
- Accent** : Green 6011
- Ceiling** : Plain
- Flooring** : Grey Carpet
- Mirror** : none
- Handrail** : S.Steel 2 pieces (for 1400 wide cabin only)

2



Natural Americas

- Wall** : Texture 4485
- Accent** : Dark Grey 7012
- Ceiling** : Plain
- Flooring** : Sand Carpet
- Mirror** : none
- Handrail** : S.Steel 2 pieces (for 1400 wide cabin only)

3



Natural Asia

- Wall** : Bright Wood 4367
- Accent** : Green 6011
- Ceiling** : Plain
- Flooring** : Grey Carpet
- Mirror** : none
- Handrail** : S.Steel 2 pieces (for 1400 wide cabin only)

1



Modern International

- Wall** : Texture 868
- Accent** : Steel Mirror
- Ceiling** : Plain
- Flooring** : White Stone
- Mirror** : none
- Handrail** : S.Steel 2 pieces (for 1400 wide cabin only)

2



Natural International

- Wall** : Concrete 585
- Accent** : Dark Grey 7012
- Ceiling** : Plain
- Flooring** : White Carpet
- Mirror** : none
- Handrail** : S.Steel 2 pieces (for 1400 wide cabin only)

3

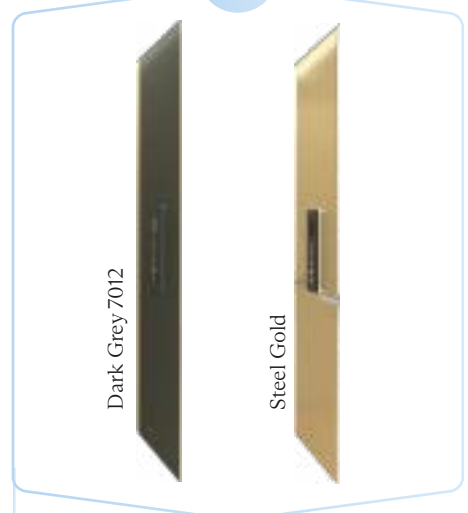

Classic International

- Wall** : Concrete 1117
- Accent** : Steel Gold
- Ceiling** : Plain
- Flooring** : Sand Stone
- Mirror** : none
- Handrail** : S.Steel 2 pieces (for 1400 wide cabin only)

Standard Cabin - Layout

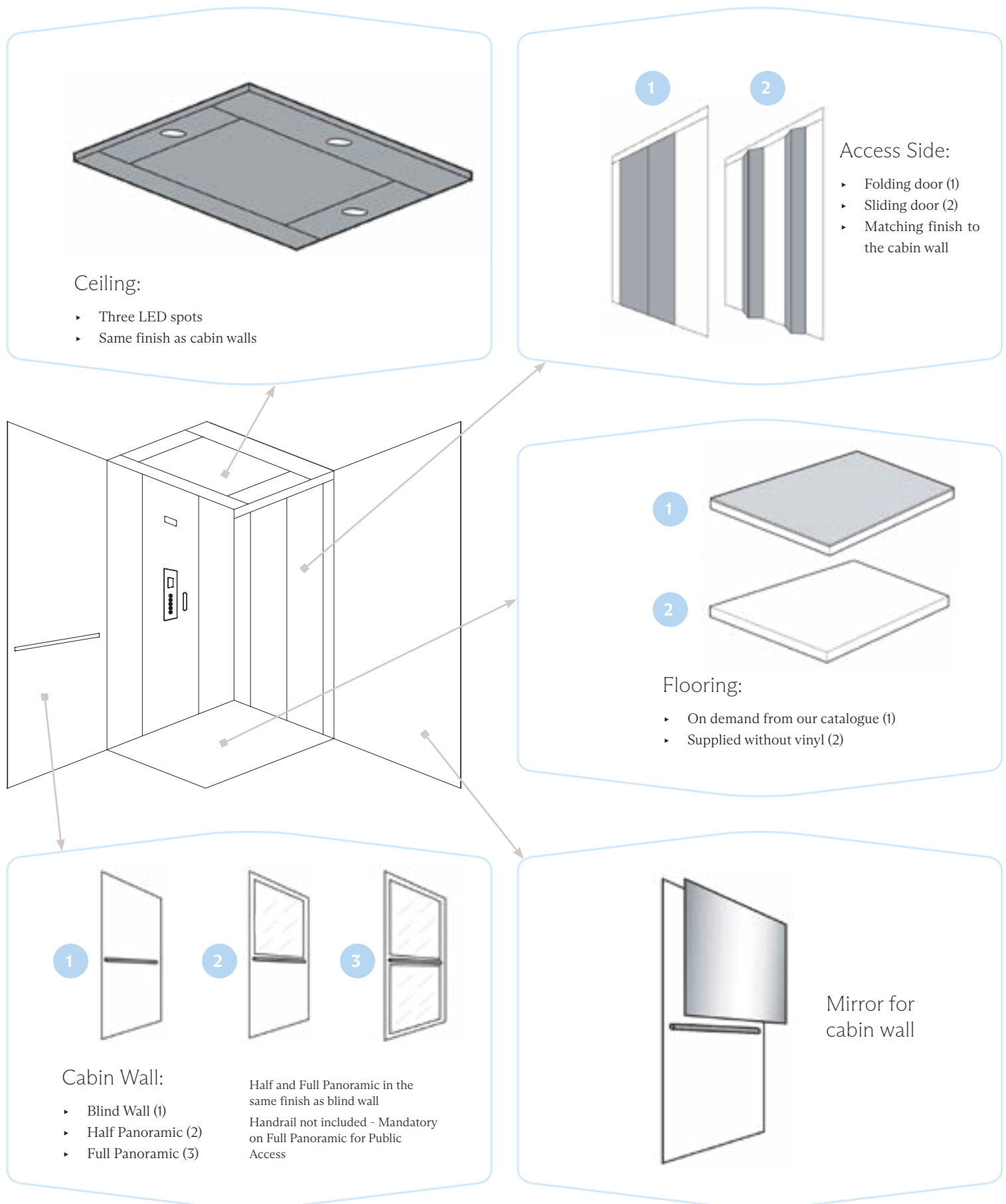

Standard Cabin - Finishes

Flooring - For both cabin and full panel with ceiling

Choose between the following options for safety vinyl flooring with guaranteed lifetime non-slippery floors.



White Vinyl



Sand Vinyl

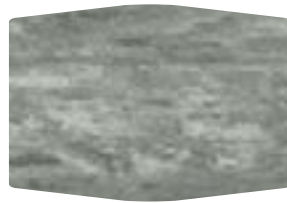

Grey Vinyl

Choose to have your lift delivered without flooring, if you want to apply your own. Max 3 mm flooring for flush top alignment

Cabin Wall

RAL Colour suggested for painted parts to match with the pre-coated steel.

PRE-COATED STEEL - PLAIN



A4 - RAL9010 (standard)



A1 - RAL9003



A13 - RAL1013



B13 - RAL5024



G1 - RAL1015



N1 - RAL7035

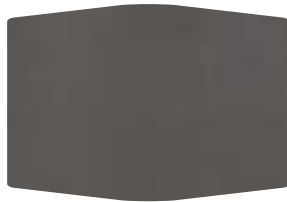

PPS - Metal Like - RAL7037

PRE-COATED STEEL - PPS



PPS1 - RAL 7035



PPS10 - RAL 9003



PPS11 - RAL 1013

STAINLESS STEEL



Stainless Steel Satin

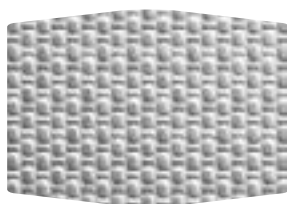

Stainless Steel Linen
(Scratch resistant finish)

Real colours and layout may differ from those shown. Slight noticeable differences are possible because of different materials. Contents subject to change without notice



RAL PAINT OF CHOICE - FOR BOTH CABIN AND FULL PANEL WITH CEILING



Standard Cabin - Optional Upgrades

Cabin Interior - Standard

- ▶ Wall - PPS Colours Standard
- ▶ Ceiling - 3 LED Spot Lights
- ▶ Hand Rail - Black on Side G
- ▶ COP - Black with TFT Colour Display, Landing
- ▶ Indicator and Voice Announcer
- ▶ Telephone
- ▶ Upto 900 mm - Finished in Skinplate
- ▶ Floor - Vinyl / Prepared for Customer Own (3mm)

Cabin Interior - Options

- ▶ Wall - RAL Colour / SS Satin / SS Linen
- ▶ Cabin External Wall Cladding in Natural
- ▶ Aluminum Per Side
- ▶ Cabin Roof Cladding in Natural Aluminum (Except Hatch Area)
- ▶ Half / Full Panoramic Wall
- ▶ Half Mirror
- ▶ Fold Down Seat - Plexiglass
- ▶ Hand Rail - SS Satin on Side G, A, B, C
- ▶ Ventilation Fan in Ceiling
- ▶ i-Button in COP instead of Key switch
- ▶ Autodialer / Autodialer + GSM
- ▶ Fire Alarm System Integration - Compatibility

Other - Options

- ▶ Power Pack Extension Upto 10 meters
- ▶ Customized plan Size out of Standards
- ▶ Oil Heater for temperature <+5 Degree Celsius
- ▶ LCD Landing Display
- ▶ Landing Door Key - Includes School Locking Function

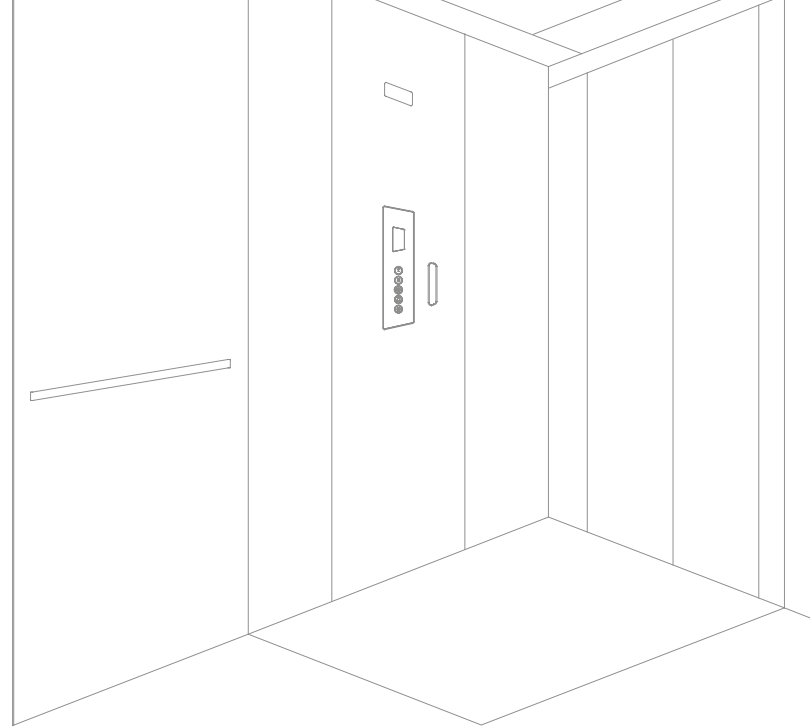

Cabin Sliding Door - Standard

- ▶ Upto 900 mm - Finished in Skinplate

Sliding Landing Door - Standard

- ▶ Upto 900 mm - Finished in Skinplate

Swing Landing Door - Standard

- ▶ Steel blind - Painted in RAL 9010
- ▶ SS Door Handle - Techno

Cabin Sliding Door - Options

- ▶ Blind - SS Satin, RAL, Special RAL
- ▶ Panoramic - Finished in SS Satin

Sliding Landing Door - Options

- ▶ Blind - SS Satin, RAL, RAL Metallic
- ▶ Panoramic - SS Satin, RAL, RAL Metallic

Swing Landing Door - Options

- ▶ Panoramic Glass on Door (Smokey Grey, Opaline, Smokey Satin, Half Reflecting)
- ▶ RAL STD Colour & Metallic
- ▶ SS Door Handle - Modern
- ▶ Automatic EVO Door Opener and Closer
- ▶ i-Button - includes School Locking Function

Shaft Structure

No rivets, no silicon, weatherproof and suitable for seismic conditions (*)

E200 can be delivered with its own patented metallic shaft

The required headroom for the shaft structure (distance from the top floor to the top of the shaft) depends on the type of top roof and landing doors. This includes a free height of 30mm between the metal shaft roof and the building for installation purposes. Elongation of the shaft is also possible.

All four sides will be clad by the shaft panels in steel or glass with a special gasket for water management. Also available are essential panels that can be mounted with silicon. It is highly recommended to use panels with gaskets for outdoor installation. It is also highly recommended to use a steel panel on side G.

The lowest and the top panels on the guide side are always provided with a round axial aerator.

Typical headroom is required with a standard cabin. Please refer to the “Feasibility Information” section for further details.

Model	Cabin without Doors	Cabin Folding Doors	Cabin Sliding Doors
E200 in concrete shaft	2300 mm	2320 mm	2450 mm / 2500 mm
E200 metal shaft header diagonals	2450 mm	2450 mm	2590 mm
E200 metal shaft roof - indoor	2470 mm	2470 mm	2610 mm
E200 metal shaft inclined roof outdoor(*)	2490 mm	2490 mm	2630 mm

According to Eurocode, seismic verification shall be checked with specific calculations and definitions of fixing points for the specific unit.

Shaft Ceiling Type

- ▶ Header diagonal
- ▶ Flat roof 1 or 2 pieces, depending on dimensions
- ▶ Inclined roof 1 or 2 pieces, depending on dimensions

Ramp

If the lift is installed without a pit, a ramp is mandatory according to EN 81-41. Please check compliance with local regulations. Usually, a boardwalk with a low incline is executed at the building site. Optionally, we can provide a ramp 120 mm high and 1000 mm long, made of aluminium to prevent slipping.

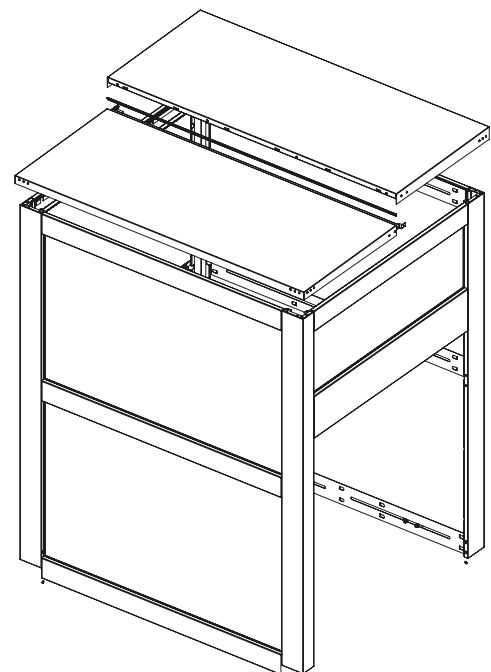

E50 - Freedom and Active Living

E50 stairlifts can fit any type of staircase, be it straight, curved, half-turn or spiral. Whether you're going up or down, you'll always experience a smooth and safe ride with E50. This compact stairlift looks simple on the outside but the technology on the inside is extremely ingenious. The patented Advanced Swivel And Levelling (ASL) technology in E50 is designed for seamless movement. E50 provides outstanding levels of comfort, confidence and craftsmanship.

Our most space-conscious stairlift, E50 is designed to blend into your home effortlessly. E50 is fitted onto your staircase and not your wall, allowing it to be installed quickly and efficiently, with minimum disruption to your home. E50 has earned many prestigious industry awards for design and innovation and is the number 1 stairlift in terms of quality and value for money.

- ▶ Reclined height-adjustable seat and footrest
- ▶ One-handed seatbelt operation and wrap-around armrests
- ▶ Can fit on a staircase as narrow as 610 mm
- ▶ Patented Advanced Swivel and Levelling technology
- ▶ Upholstery collections
- ▶ Quick and efficient installation

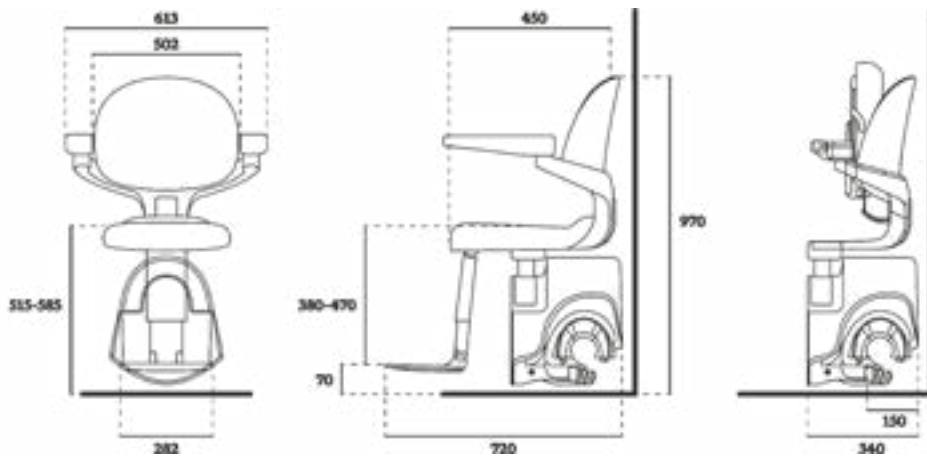

Where not directly specified, measurements are in millimetres.

Vinyl

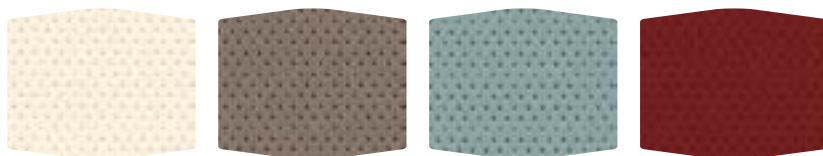

Natural Beige Basalt Grey Pearl Blue Deep Red

Fabric

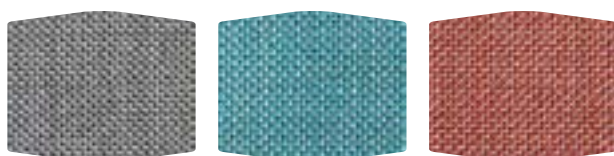

Mountain Grey Mineral Blue Coral Orange

Wood



Grey Oak

Leather



Firenze Smoke Firenze Tan Firenze Grey



Thanks to proven monorail concept and patented ASL Technology the Flow rotates to the most optimal and safe position during the ride.



When the lift is folded up, there is still plenty of space for other stair users.



Different vertical start options enables installations even closer to doors.





Straight



Curved



With a comfortable soft touch grip, the integrated joystick is designed for you to fold away neatly in the armrest when not in use.



Open



Ergonomic Seatbelt

Speed Max	0.1 m/s
Drive Type	Rack and pinion
Motor Wattage	350W
Weight Capacity	125kg (275 lbs)
Automatic Stop	Yes
Staircase Incline	Upto 72°
Operation	Armrest detection and foldable
Joystick	Control as standard
Batteries	2 × 12V batteries, total 24V
Certification	Machinery Directive 2 006 / 42 / ECN 81-40
Model Code	RP00-CU
Footrest	Available in 2 sizes - Adjustable to 5 positions
Seat Height	Adjustable to 4 positions 515-585mm (floor to top of seat)



Stay connected with friends and family with up to three different telephone numbers contactable directly from your stairlift.



Mr. Kiran Kumar

“I recommend Elite Lifts to everyone like me or everyone to enjoy an independent living.”



Padma Shri Dr Bhathavasthalam

“Initially, we were very doubtful if an elevator can be installed in such tight spacing but Elite made it possible. It's been six years now but the sleek design easily still becomes the talk of my house.”



Mr Syed Ahmed Mohiuddin

“I love the fact that the whole elevator is designed to be eco-friendly, it just runs on a single-phase power supply consuming very minimal power.”



Mr Abdul Basheer

“The technical team was very good. They took the prior appointment, they knew their job and I think within just a few hours they made the lift up & running.”



Mr Rakesh Suri

“It is very compatible, consumes single-phase power & can easily fit in our house.”



Dr BM Girish

“The biggest advantage of this lift is that it's Vaastu compliant. With no pit/no headroom, you can easily install it at any corner of the house, with next to zero civil work.”



Mrs. Desai

“Already I'm suggesting to some of my friends and relatives who want to know the details, we are very happy with the company.”

Elite Families



AUSTRALIA EXPERIENCE CENTRES

Brisbane | Melbourne | Sydney



INDIA EXPERIENCE CENTRES

Ahmedabad | Bangalore | Bhubaneswar | Chandigarh
Chennai | Delhi | Hyderabad | Indore | Jaipur | Kochi | Kolkata
Lucknow | Mangalore | Mumbai | Pune | Visakhapatnam



MALAYSIA EXPERIENCE CENTRE

The Elite Elevators SDN BHD
G-13 Fera Residence, No 47 Jalan 34/26, Wangsa Maju, 53300 Kuala Lumpur.



All India Contact:

+91 93616 13131 | 044 2490 2828

Our Presence In INDIA

Ahmedabad | Bangalore | Bhubaneswar
Chandigarh | Chennai | Delhi | Hyderabad | Indore
Jaipur | Kochi | Kolkata | Lucknow | Mangalore
Mumbai | Pune | Visakhapatnam

Our International Presence

Australia | Malaysia | UAE



Scan here to
find your nearest
experience centre